



# YILKAR



## Ahşap Bağlantı Elemanları



# YILKAR

METAL MAKİNE MÜHENDİSLİK SANAYİ LİMİTED ŞİRKETİ

## 9X9 FLANŞ

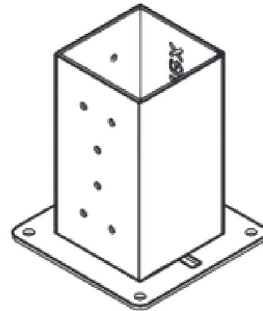
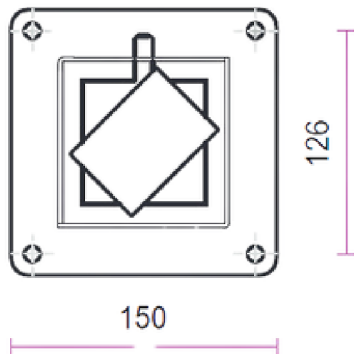
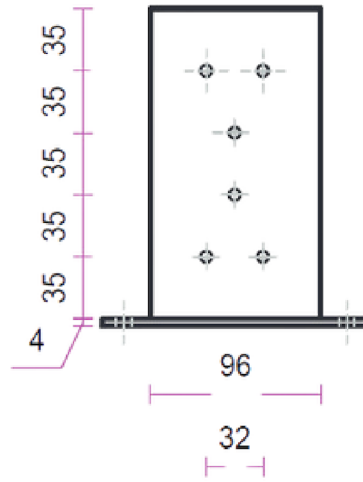
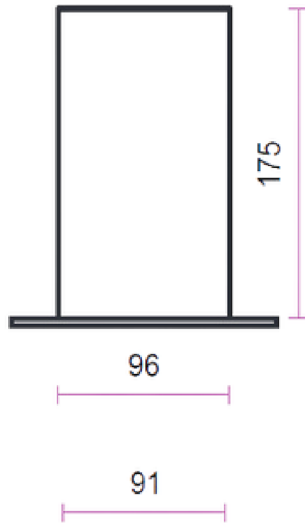



# YILKAR

METAL MAKİNE MÜHENDİSLİK SANAYİ LİMİTED ŞİRKETİ

## 9X9 3LÜ KÖŞE

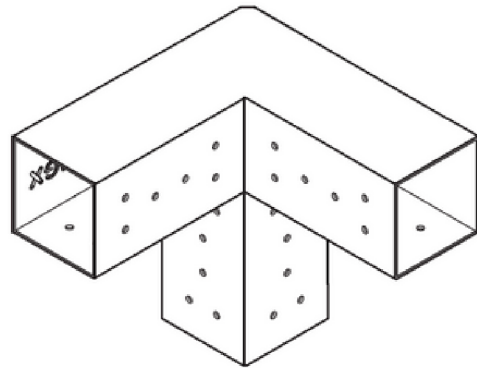
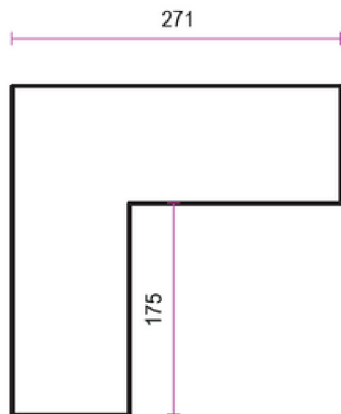
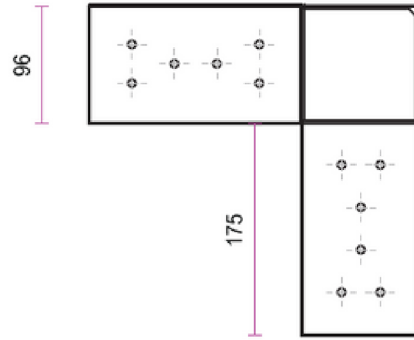
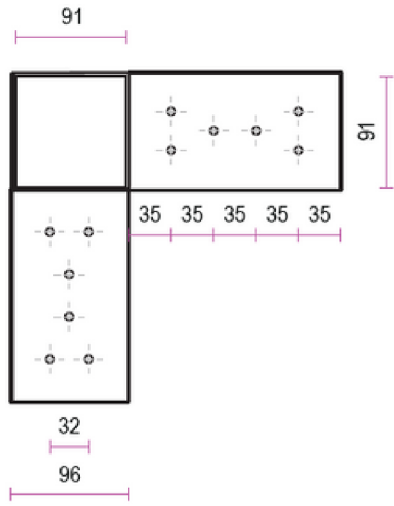
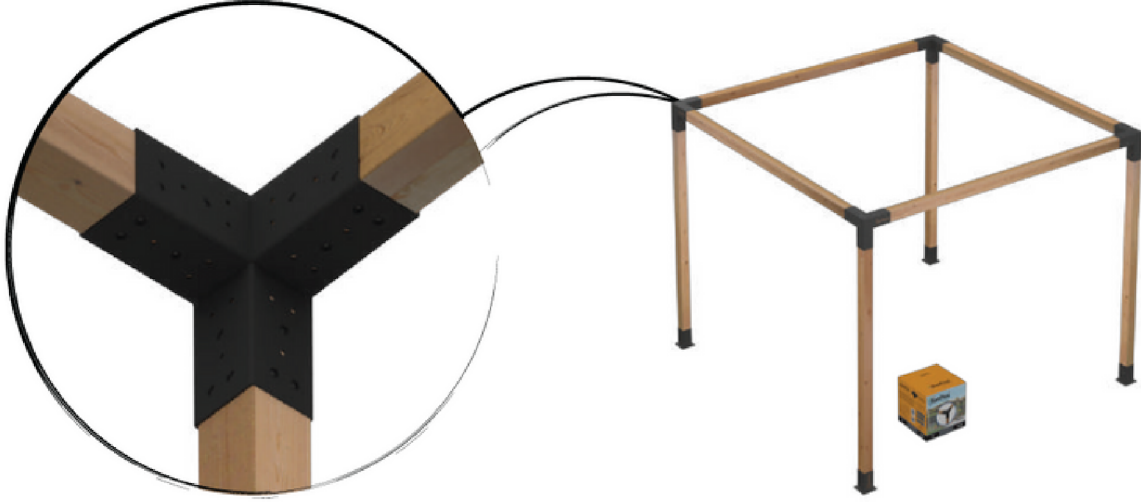



# YILKAR

METAL MAKİNE MÜHENDİSLİK SANAYİ LİMİTED ŞİRKETİ

## 9X9 4LÜ KÖŞE

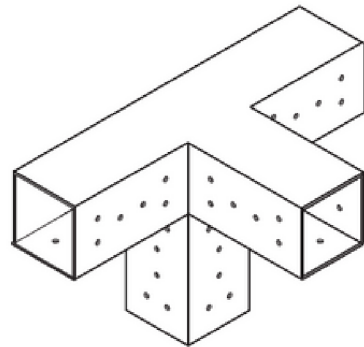
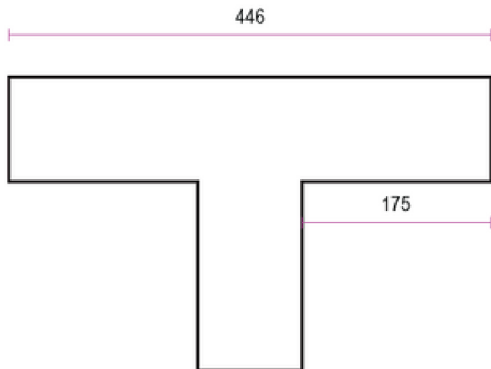
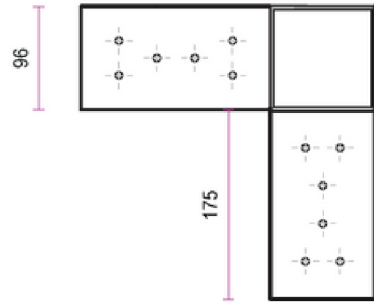
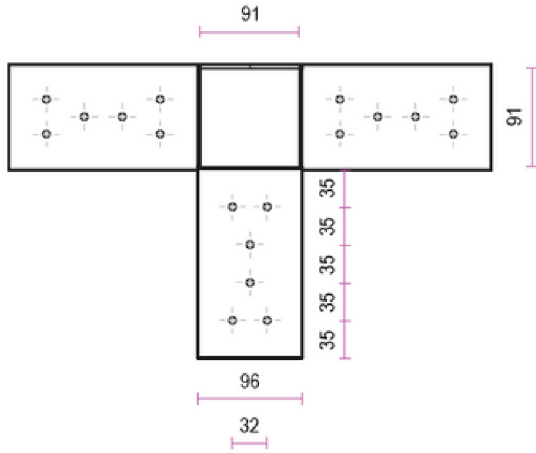
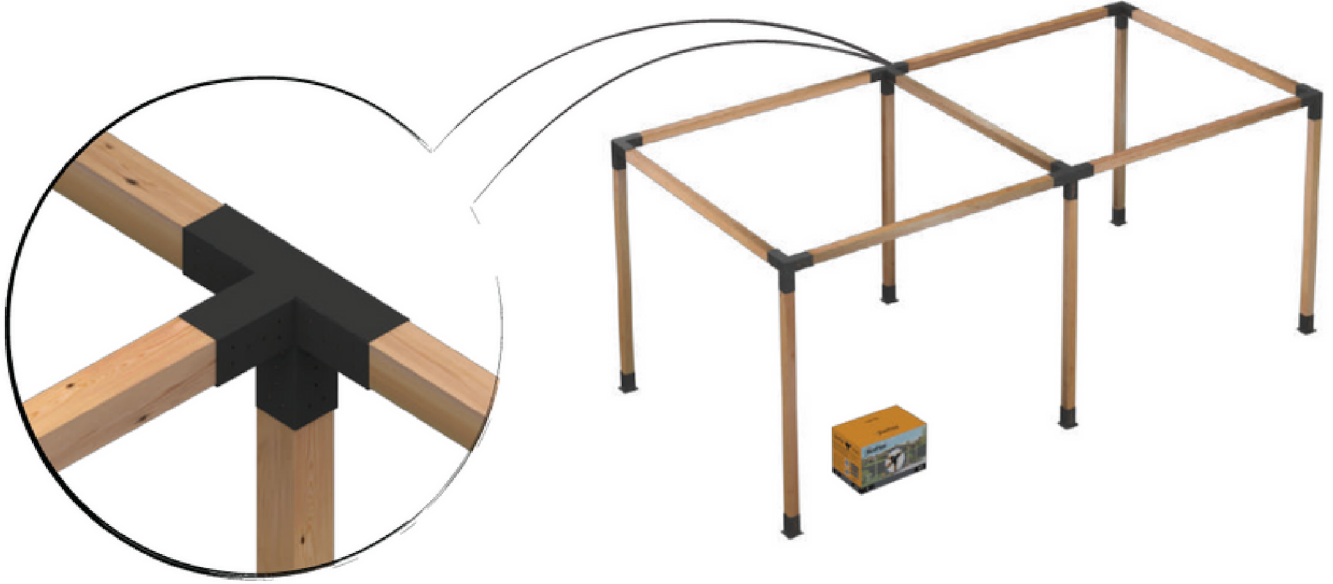



# YILKAR

METAL MAKİNE MÜHENDİSLİK SANAYİ LİMİTED ŞİRKETİ

## 9X9 5 Lİ KÖŞE

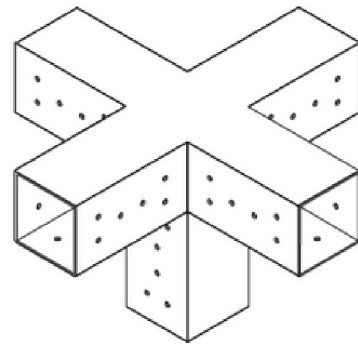
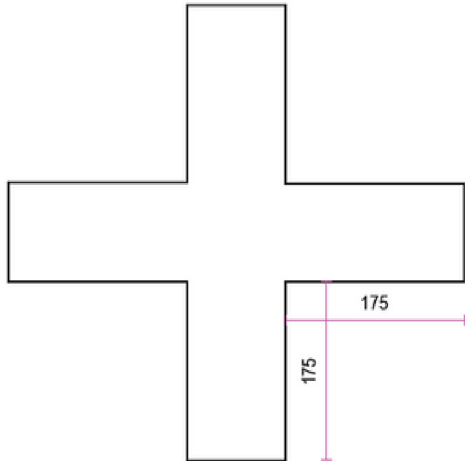
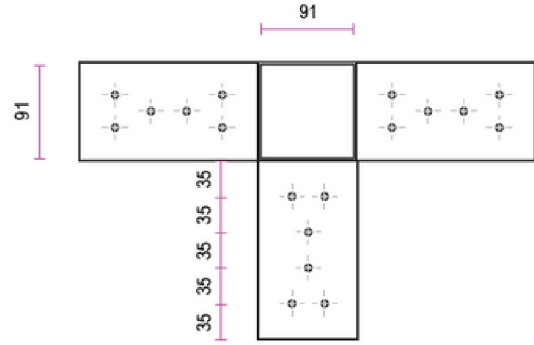
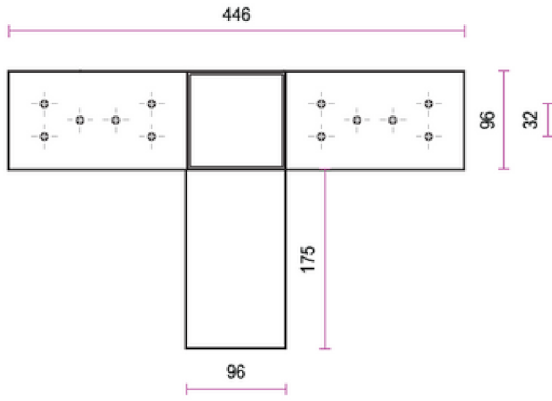
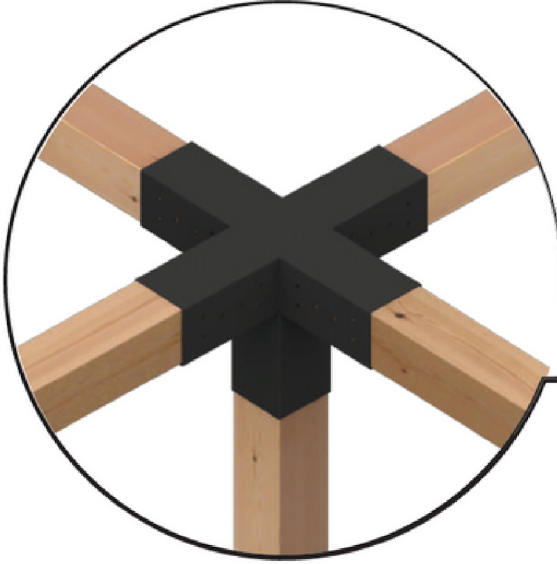



# YILKAR

METAL MAKİNE MÜHENDİSLİK SANAYİ LİMİTED ŞİRKETİ

## 9X9 5 Lİ KÖŞE

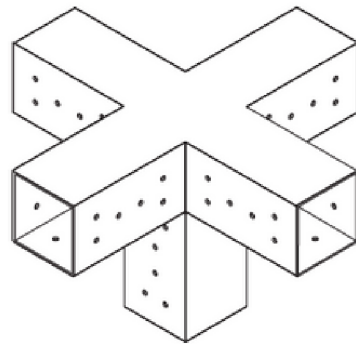
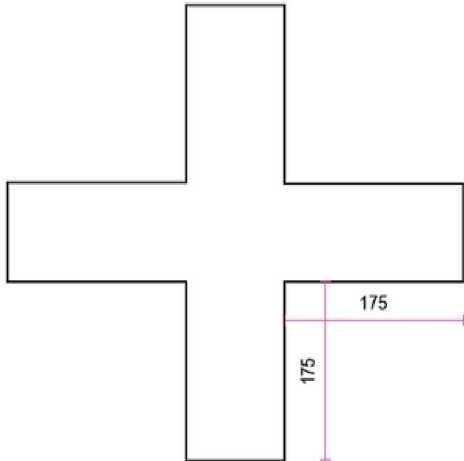
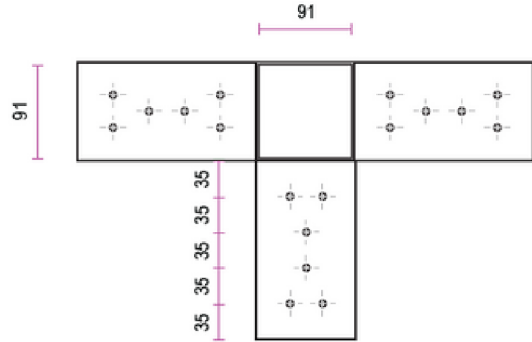
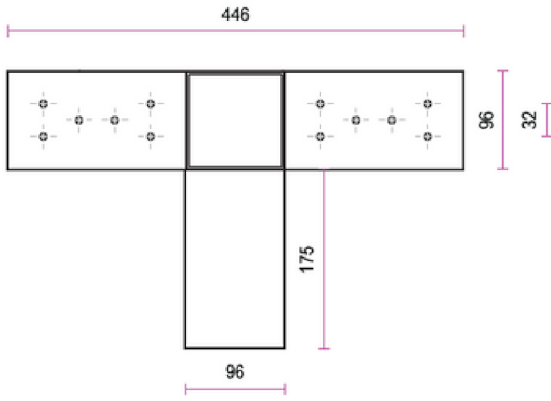



# YILKAR

METAL MAKİNE MÜHENDİSLİK SANAYİ LİMİTED ŞİRKETİ

## 9X9 X KÖŞE

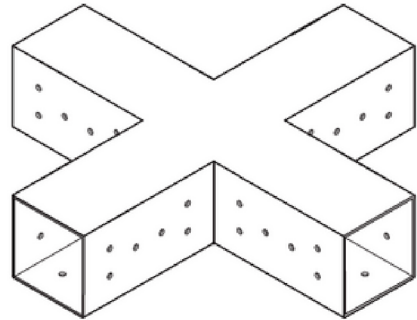
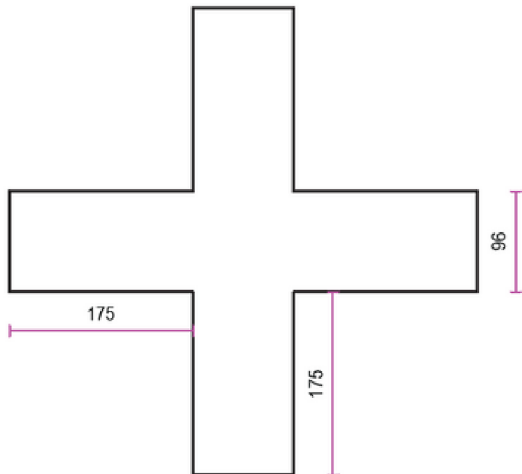
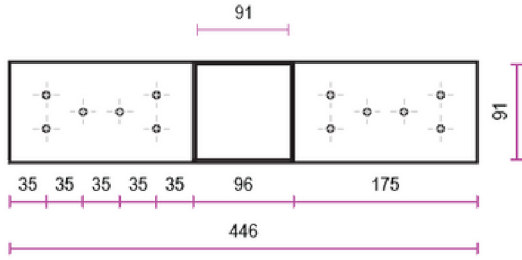
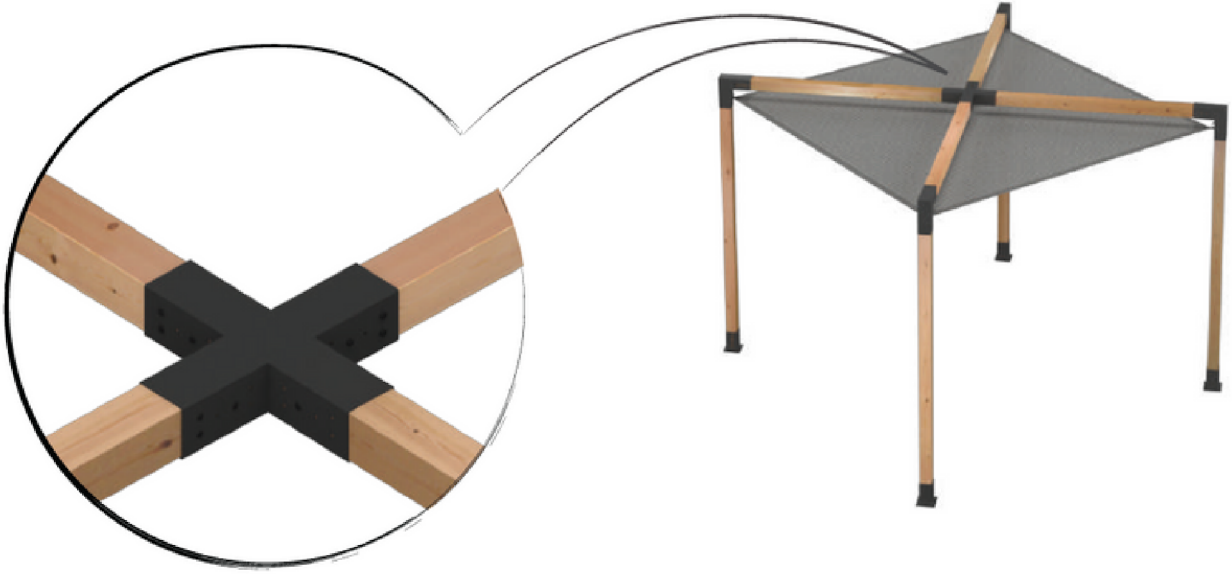



# YILKAR

METAL MAKİNE MÜHENDİSLİK SANAYİ LİMİTED ŞİRKETİ

## 9X9 T KÖŞE

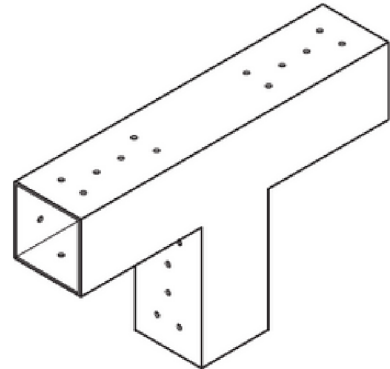
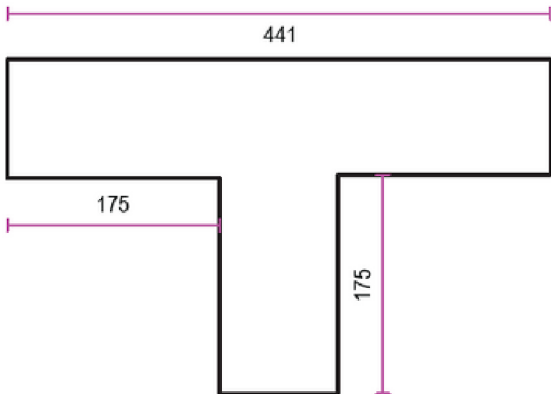
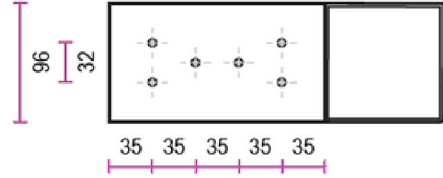
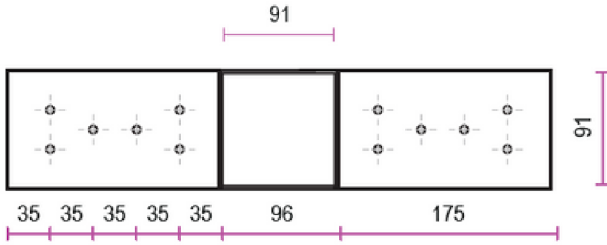
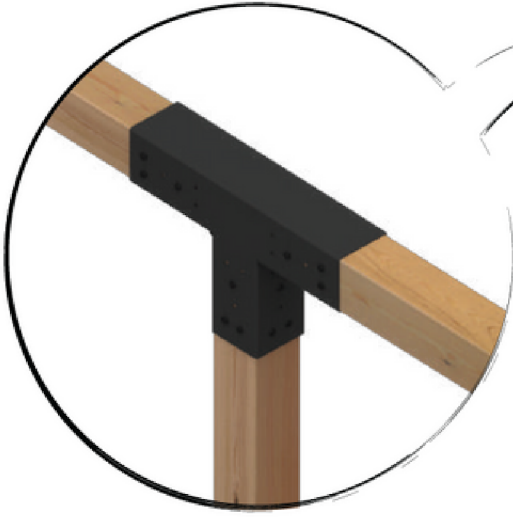





# YILKAR

METAL MAKİNE MÜHENDİSLİK SANAYİ LİMİTED ŞİRKETİ

## 9X4 BİRLEŞİK KÖŞE

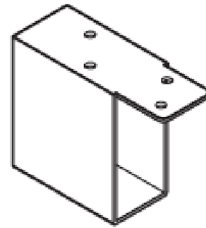
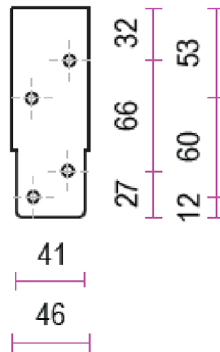
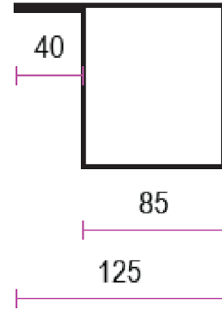
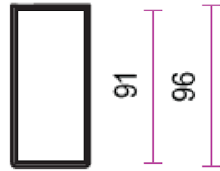
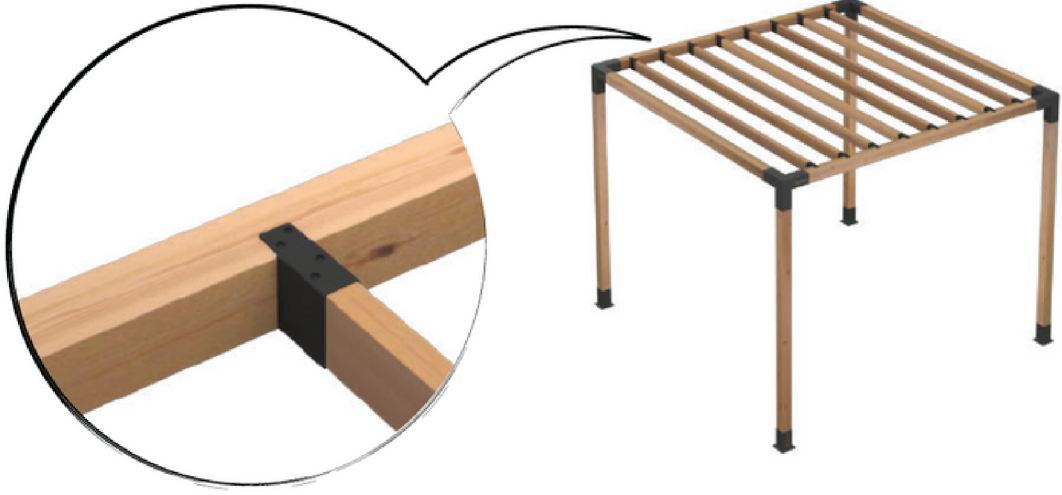



# YILKAR

METAL MAKİNE MÜHENDİSLİK SANAYİ LİMİTED ŞİRKETİ

## 9X4 BİRLEŞİK KÖŞE 2

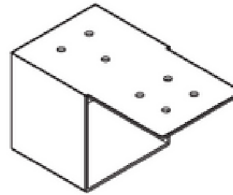
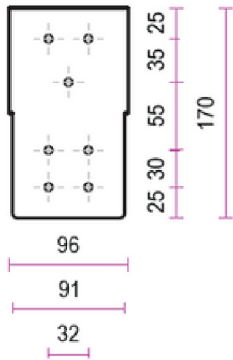
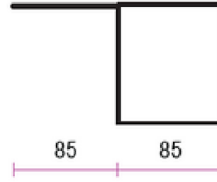
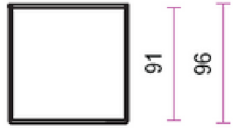
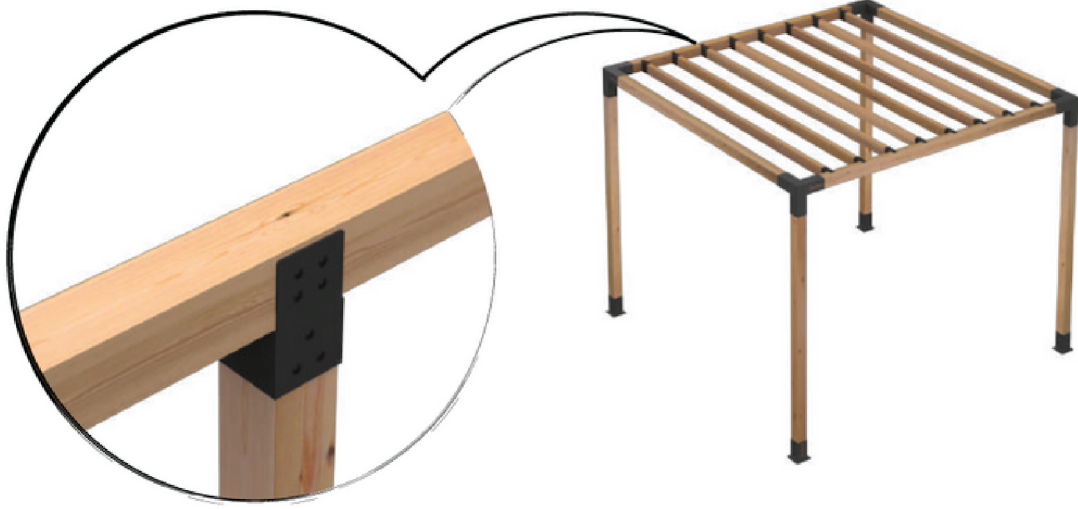



# YILKAR

METAL MAKİNE MÜHENDİSLİK SANAYİ LİMİTED ŞİRKETİ

## 9X4 BİRLEŞİK KÖŞE 3

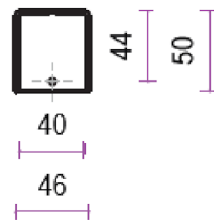
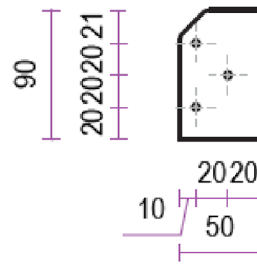
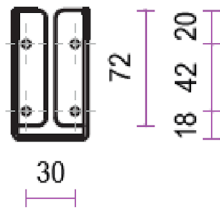
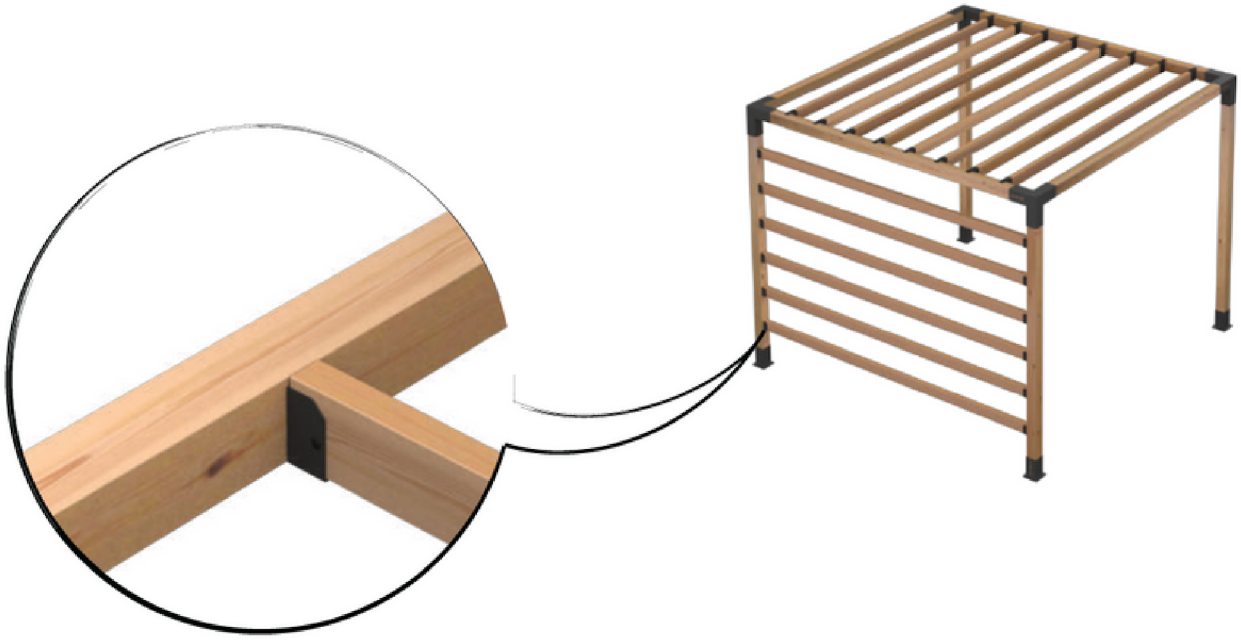



# YILKAR

METAL MAKİNE MÜHENDİSLİK SANAYİ LİMİTED ŞİRKETİ

## 9X4 BİRLEŞİK KÖŞE 4

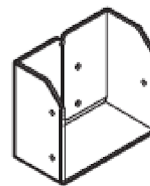
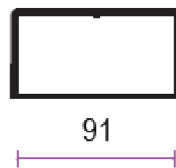
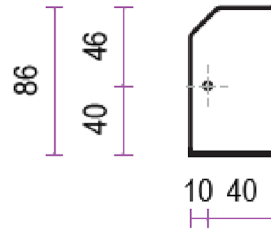
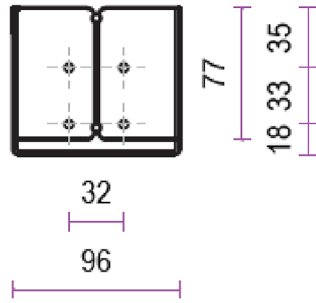
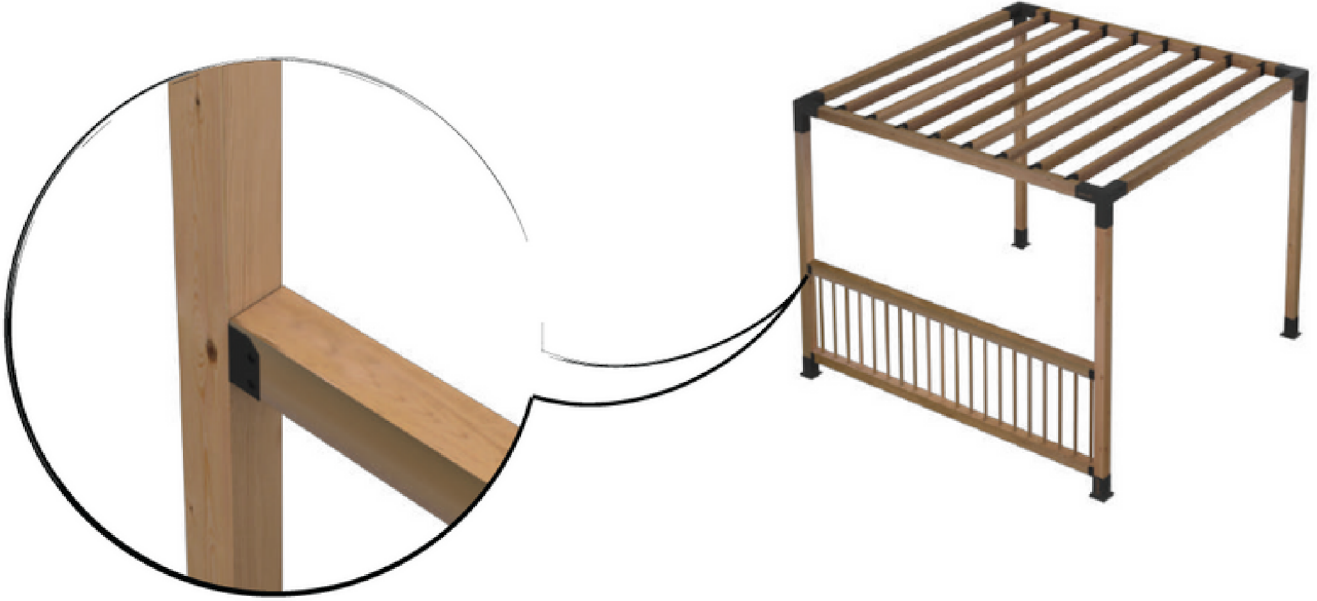



# YILKAR

METAL MAKİNE MÜHENDİSLİK SANAYİ LİMİTED ŞİRKETİ

## 9X4 45 KÖŞE 1

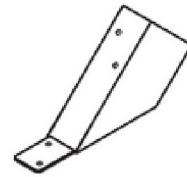
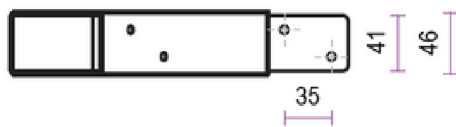
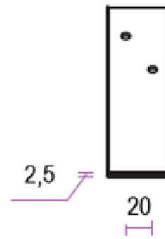
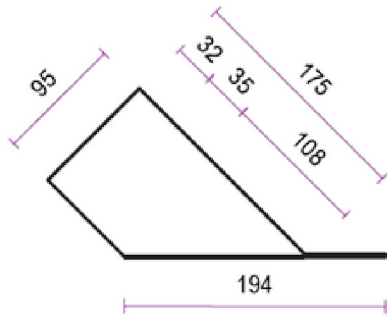



# YILKAR

METAL MAKİNE MÜHENDİSLİK SANAYİ LİMİTED ŞİRKETİ

## 9X9 45 KÖŞE 1

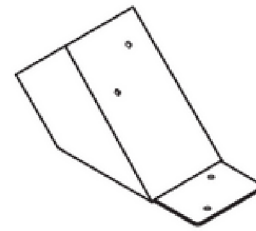
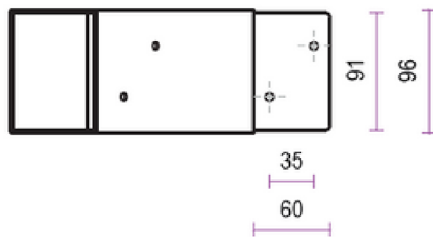
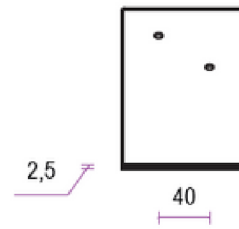
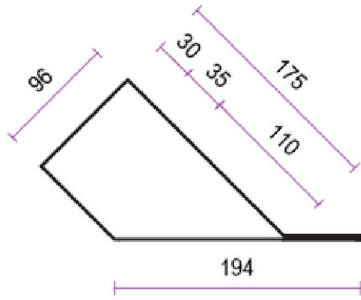



# YILKAR

METAL MAKİNE MÜHENDİSLİK SANAYİ LİMİTED ŞİRKETİ

## 9X9 AÇILI FLANŞ

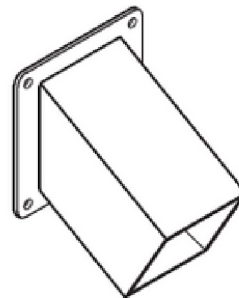
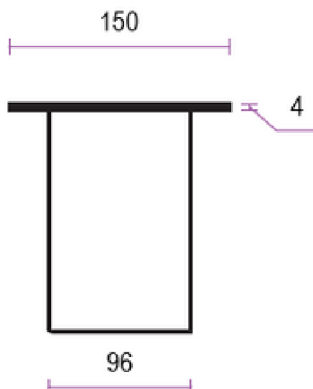
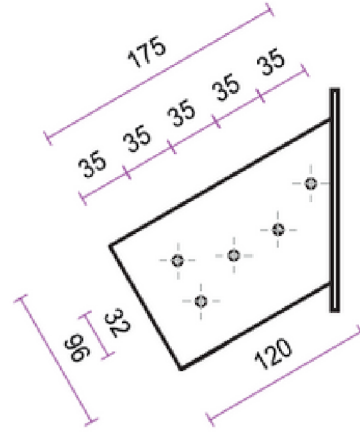
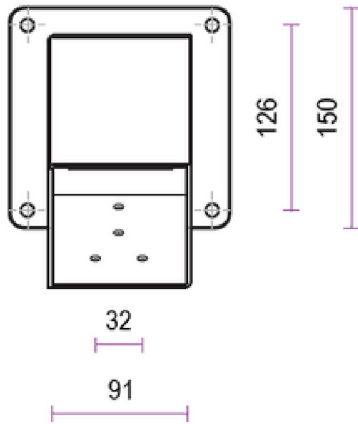



# YILKAR

METAL MAKİNE MÜHENDİSLİK SANAYİ LİMİTED ŞİRKETİ

## 9X9 AÇILI 3LÜ KÖŞE

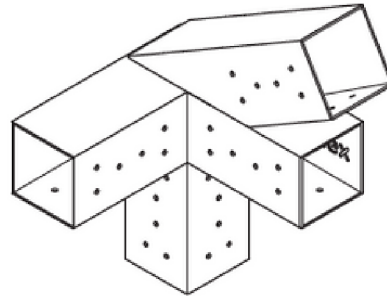
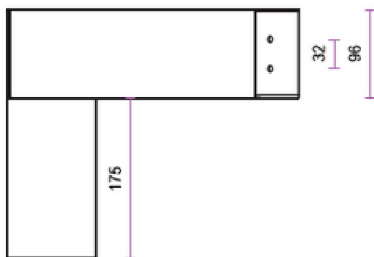
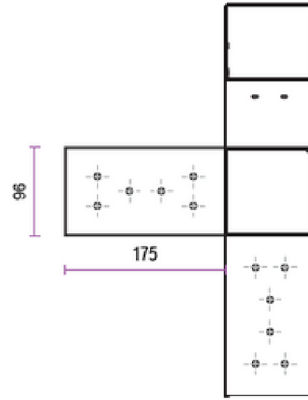
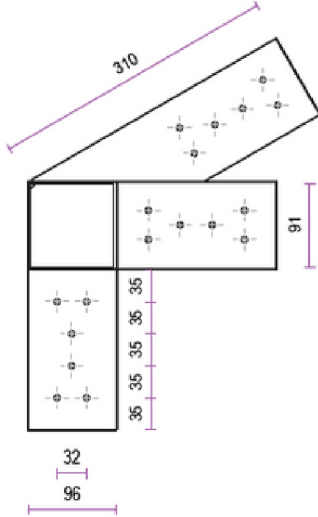
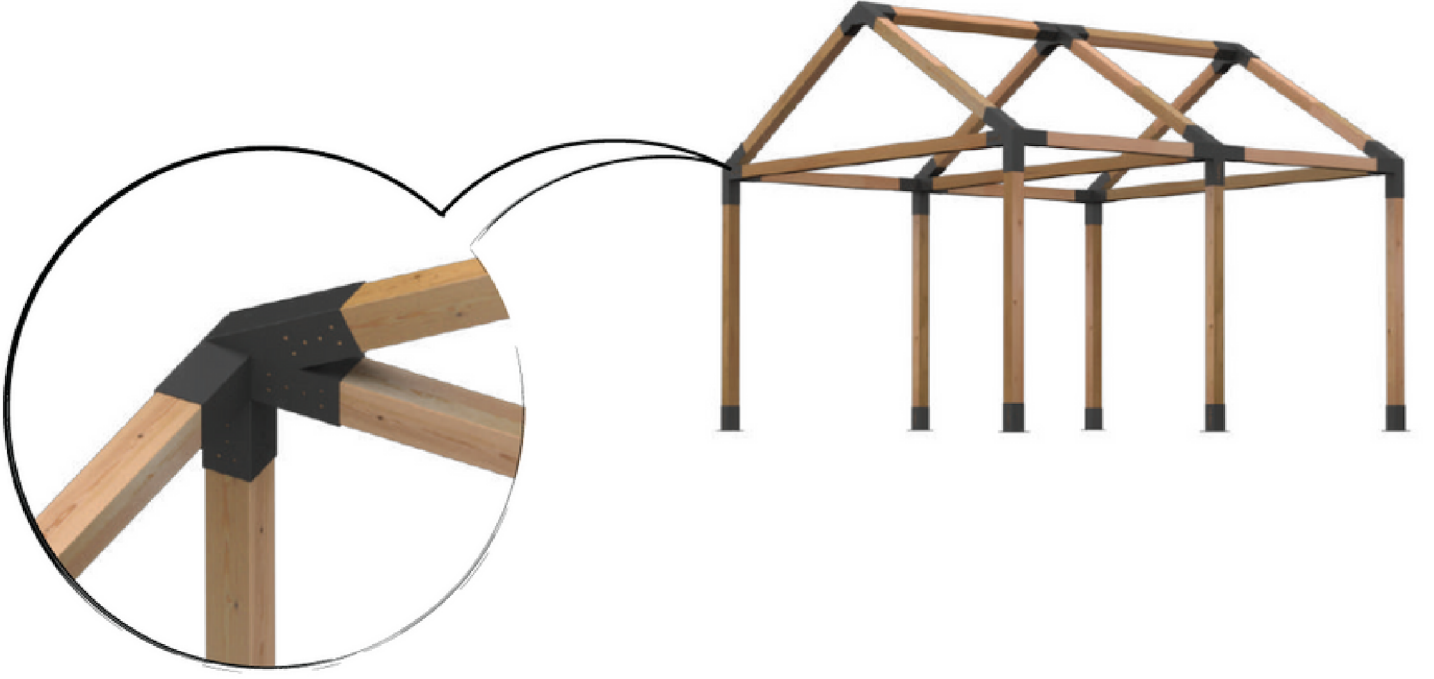







# YILKAR

METAL MAKİNE MÜHENDİSLİK SANAYİ LİMİTED ŞİRKETİ

## 9X9 ÇATI 3LÜ ORTA KÖŞE

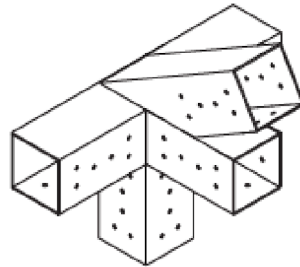
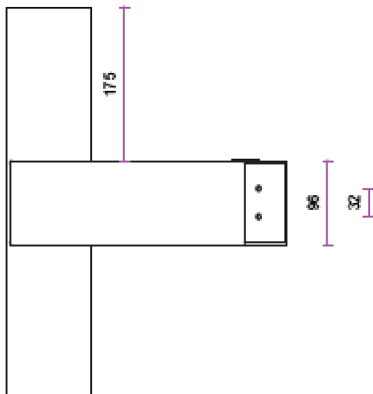
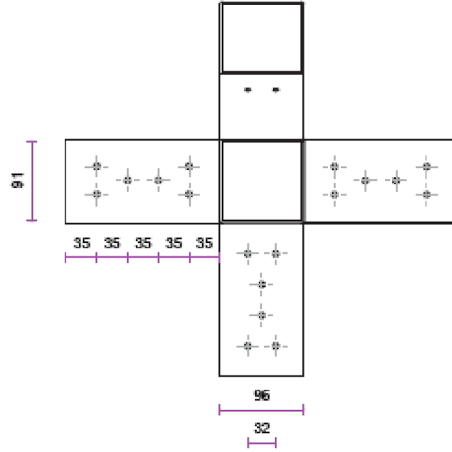
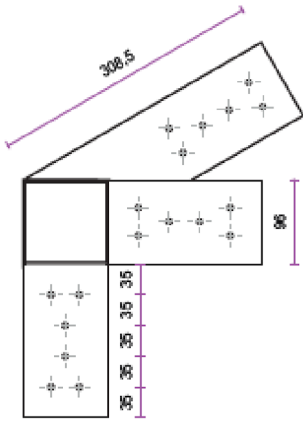



# YILKAR

METAL MAKİNE MÜHENDİSLİK SANAYİ LİMİTED ŞİRKETİ

## 9X9 ÇATI ORTA KENAR KÖŞE

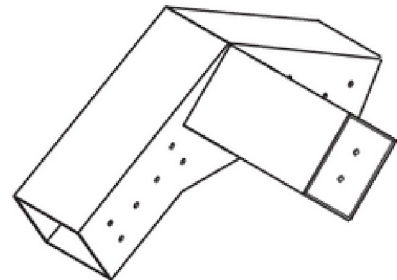
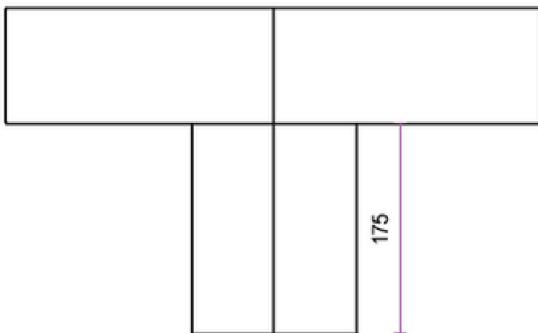
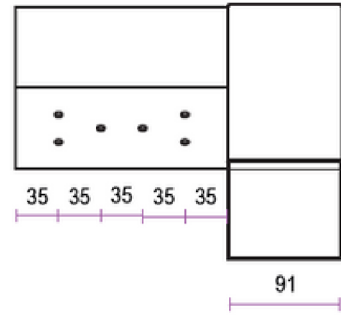
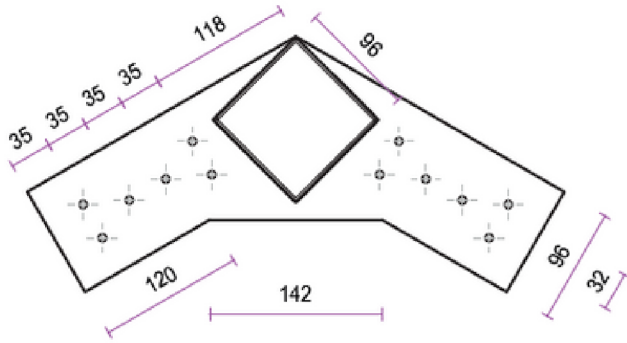
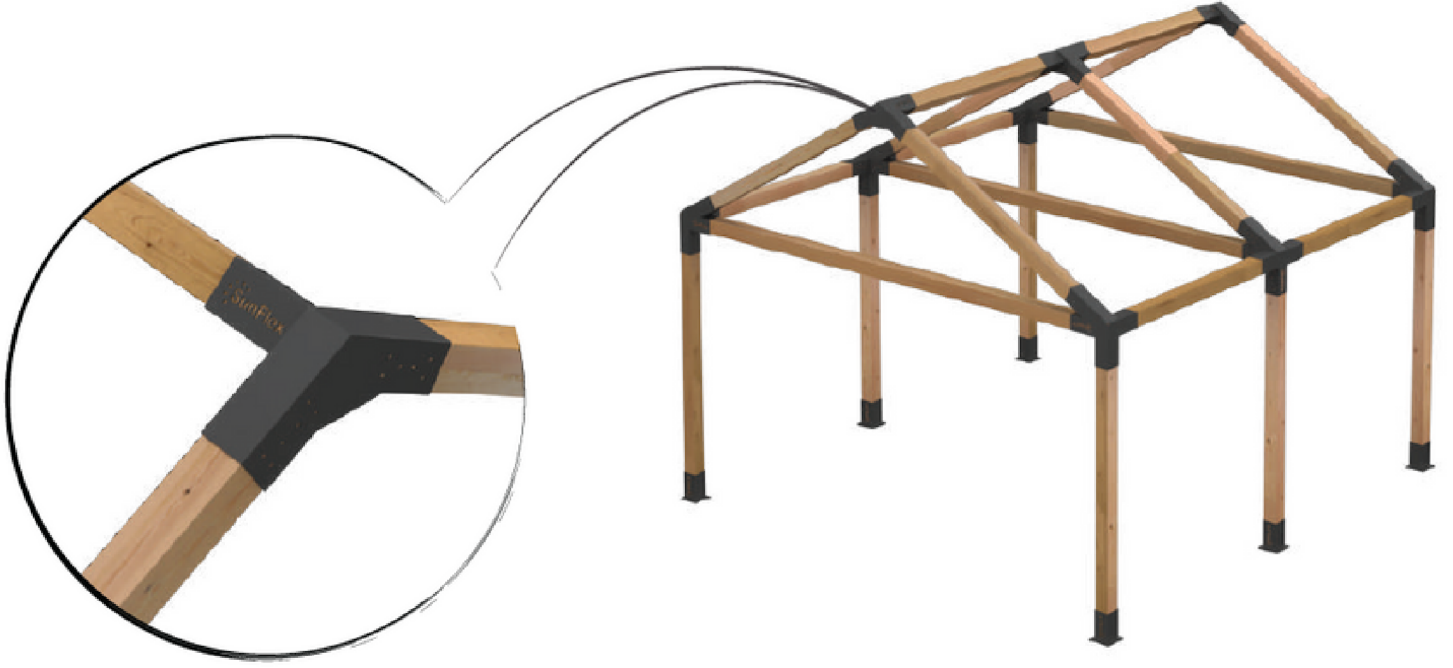



# YILKAR

METAL MAKİNE MÜHENDİSLİK SANAYİ LİMİTED ŞİRKETİ

## 9X9 ÇATI 3LÜ ORTA KÖŞE

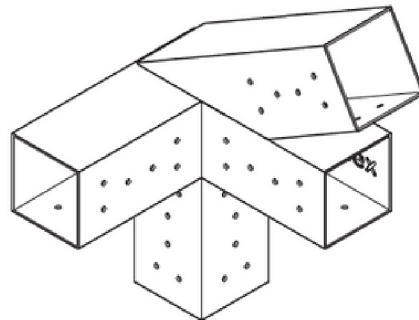
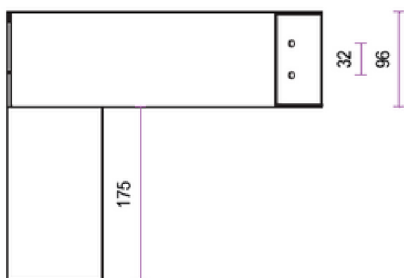
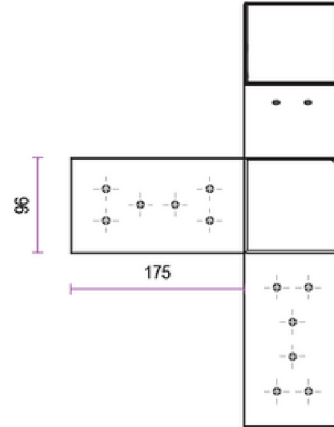
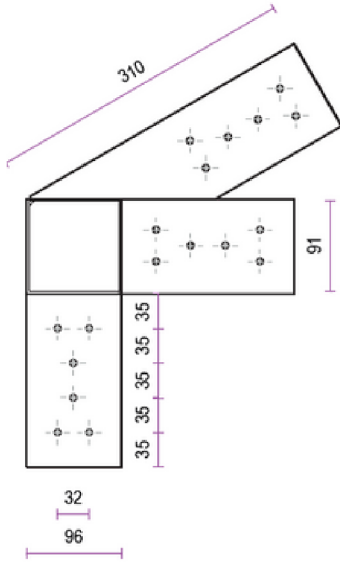
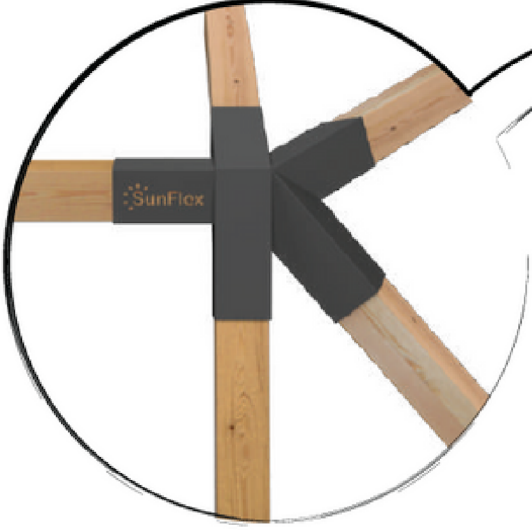



# YILKAR

METAL MAKİNE MÜHENDİSLİK SANAYİ LİMİTED ŞİRKETİ

## 9X9 ÇATI ORTA

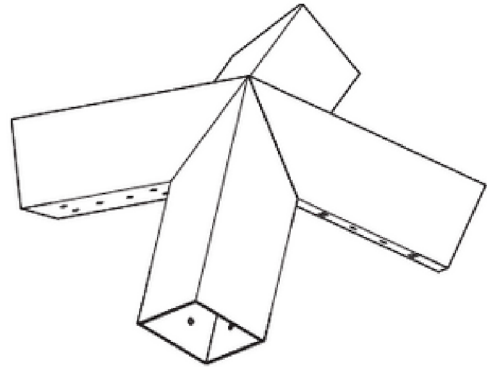
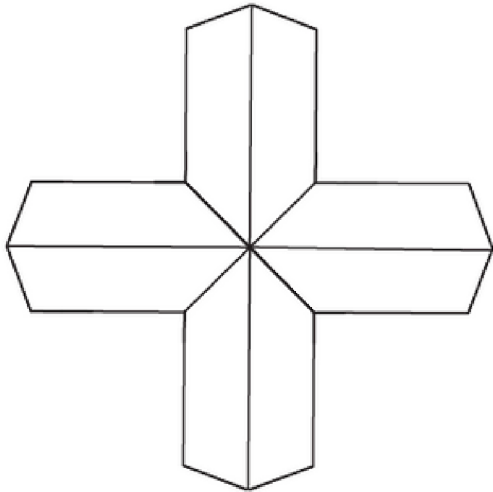
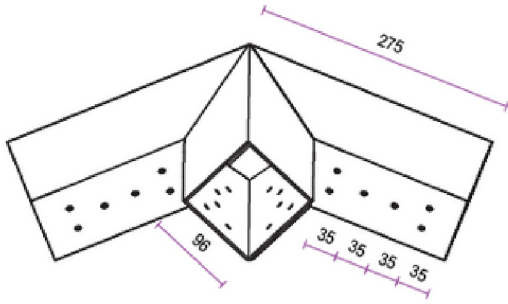
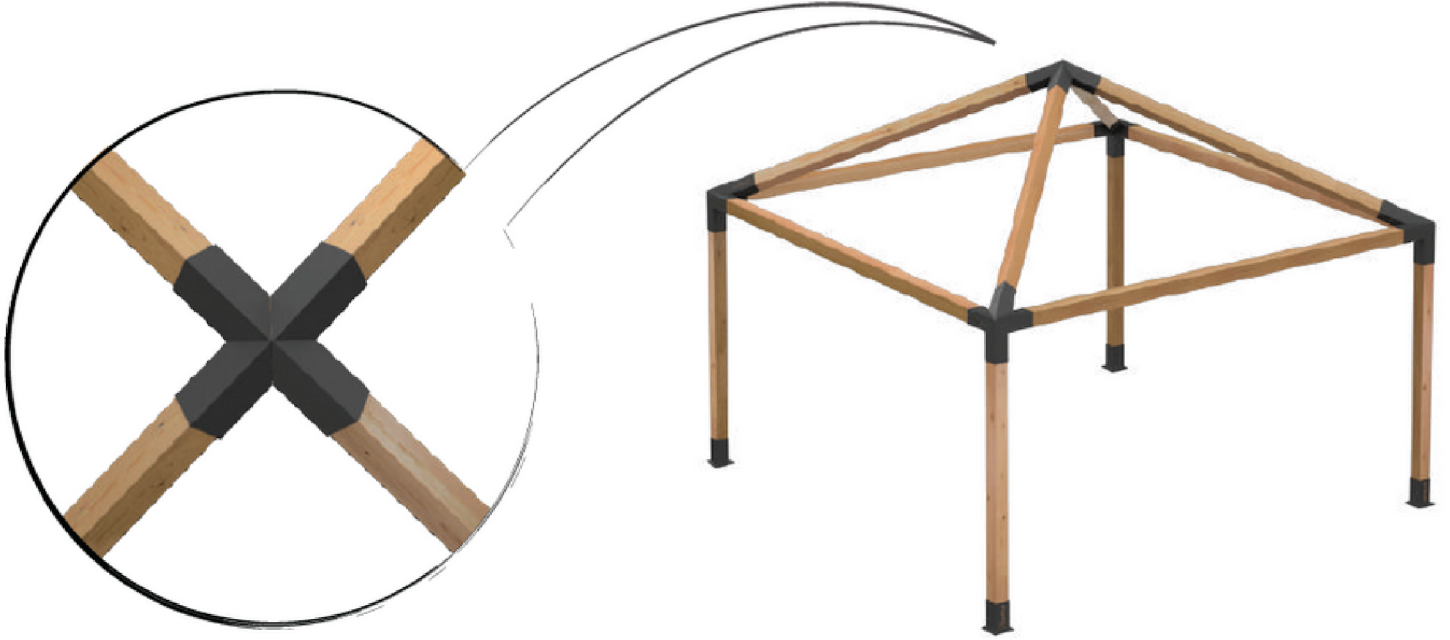



# YILKAR

METAL MAKİNE MÜHENDİSLİK SANAYİ LİMİTED ŞİRKETİ

## 9X9 ÇATI ORTA 2

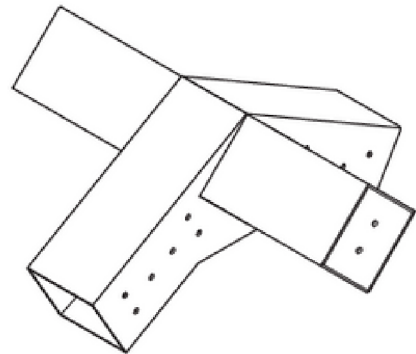
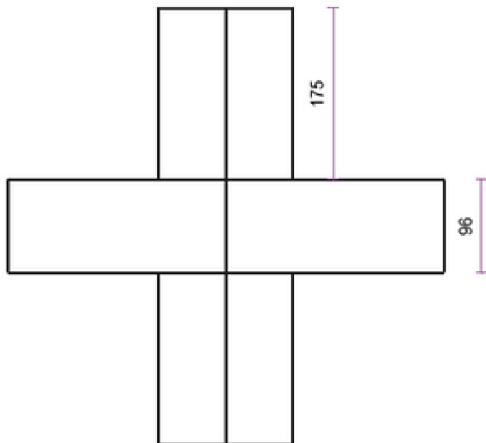
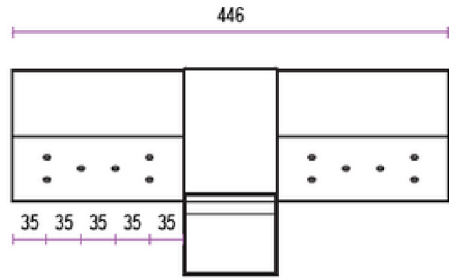
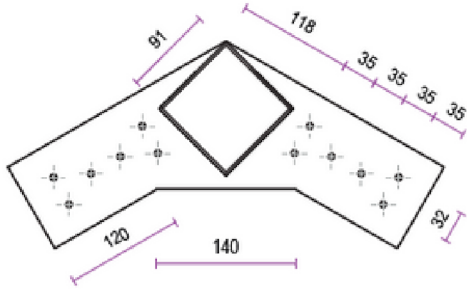
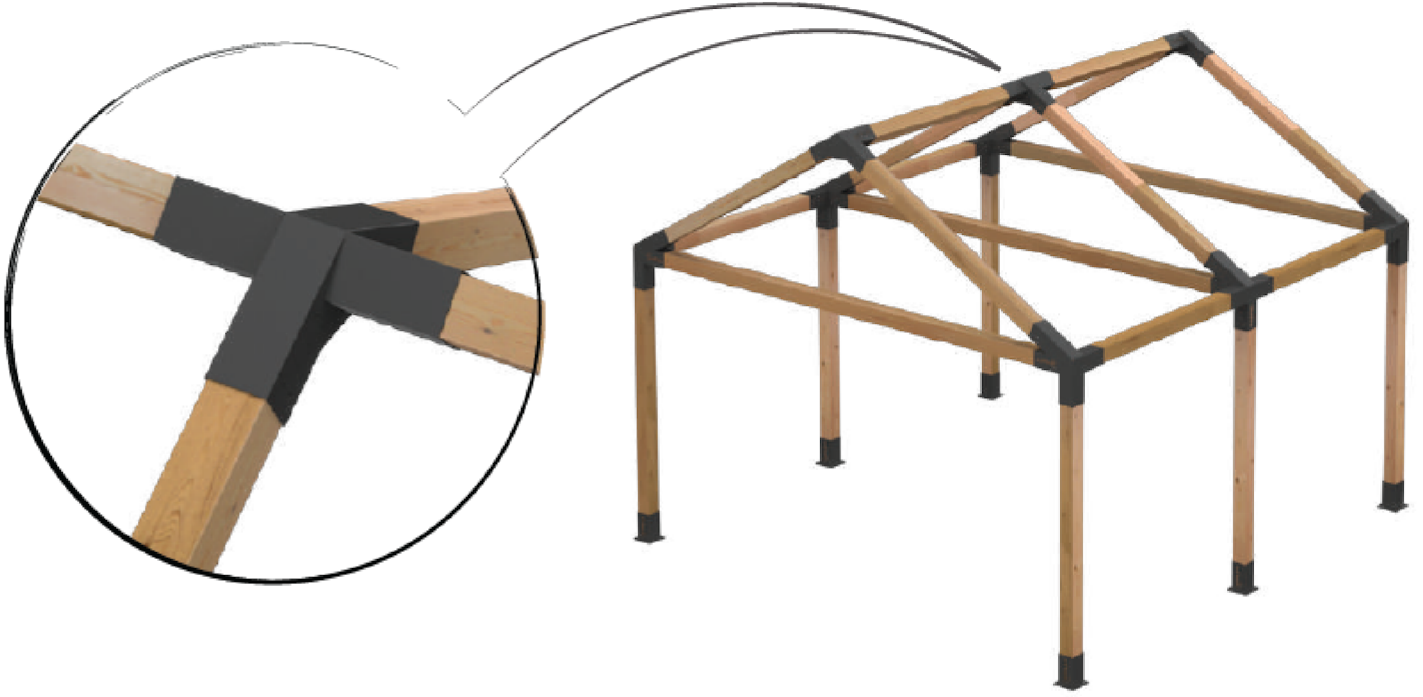



# YILKAR

METAL MAKİNE MÜHENDİSLİK SANAYİ LİMİTED ŞİRKETİ

## 9X9 ÇATI ORTA 2

